



## INSTALLATION TRUNKINGS

- made from plastic
- made from halogen-free plastic
- made from sheet steel

**GGK** is an owner managed German company. In alliance with the sister company WEST-CHEMIE, a manufacturer of PVC granulates, the production process starts with the manufacturing of raw material. Furthermore, **GGK** possesses both the technical process know-how in the extrusion of profiles and a unique innovative product

range. **GGK** has been established on the market of electrical installations for more than 25 years and is nowadays one of the leading European companies and a Specialist in terms of the manufacturing and the distribution of cable management systems made from PVC, halogen-free plastics, aluminium and sheet steel.



**LFG / FB** Installation trunking systems



**BR / MBR** Wall trunking systems



**RS** Installation pole systems



**VVE** Prewired units



**SL** Skirting trunking systems

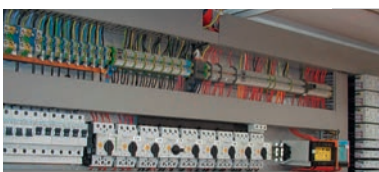

**VK** Slotted cable trunking systems

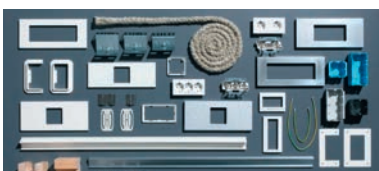

Wide range of accessories

# INSTALLATION TRUNKING SYSTEM (plastic / halogen-free)

## Purpose of the system and usage recommendation for the MINI and LFG installation trunking system:

Installation in offices, residential spaces, workshops, warehouses and schools regularly subject to high mechanical loads and with functional interior architectural designs (museums, galleries, doctors' offices).

## Mounting properties and system accessories for the MINI and LFG installation trunking system (excerpt of product range):

Base and cover of the trunkings are 2 m in length and the trunking base is perforated. The cover piece covers the base completely and the trunking base is easy to access so there is space for installing the cables. It is possible to change the direction elegantly using products from the full range of accessories. Molded cover parts (inside corners, outside corners, vertical corners, T-pieces) are available to hide cut edges. End pieces can be inserted to obtain a clean look. Colour: pure white (9010); other colours on request.

## Device installation / mounting options for the MINI and LFG installation trunking system:

MB modular boxes are available for the use of M45 device modules. MR modular frames are available for the use of M45 device modules.

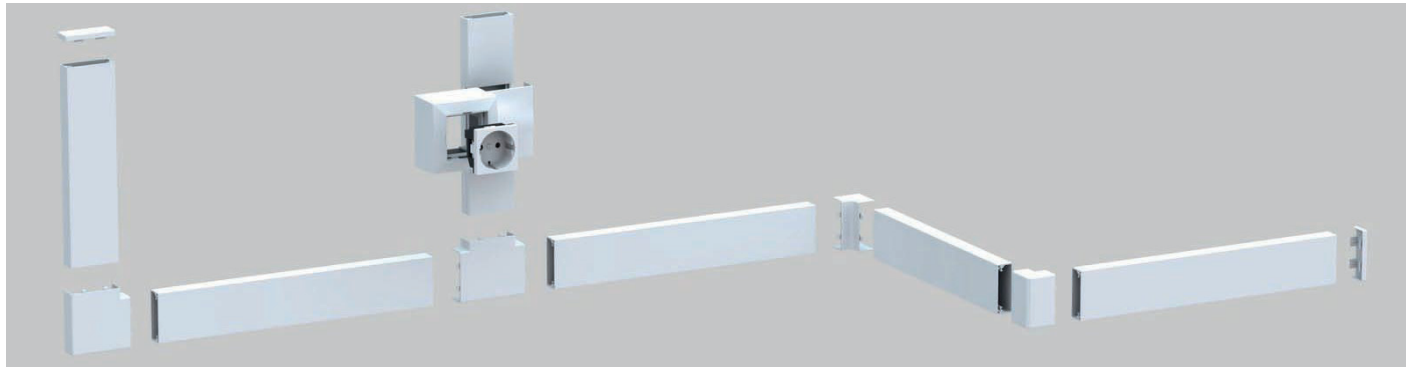

	Dimension height x width	Colour	Wiring <sup>A</sup>		Set base+cover	Inside corner	Outside corner	End piece	Vertical corner	T-piece	Modular box* M45
			NYM J3x1,5 Ø 9,1mm	CAT 7 (data) Ø 8,0mm							
<b>MINI 10x20</b> plastic	10x20mm	white 9010	1	1	<b>12413</b> pack.: 72 m	<b>214523</b> pack.: 4 pc.	<b>214553</b> pack.: 4 pc.	<b>214563</b> pack.: 10 pc.	<b>214573</b> pack.: 4 pc.	<b>212487</b> pack.: 10 pc.	<b>16656</b> pack.: 1 pc.
<b>MINI 10x20 hf</b> halogen-free plastic	10x20mm	white 9010	1	1	<b>4107</b> pack.: 72 m	<b>14510</b> pack.: 4 pc.	<b>14511</b> pack.: 4 pc.	<b>14512</b> pack.: 10 pc.	<b>14512</b> pack.: 4 pc.		
<b>MINI 10x30</b> plastic	10x30mm	white 9010	1	2	<b>11514</b> pack.: 110 m	<b>14528</b> pack.: 4 pc.	<b>14558</b> pack.: 4 pc.	<b>14568</b> pack.: 10 pc.	<b>14578</b> pack.: 4 pc.	<b>12107</b> pack.: 4 pc.	<b>16657</b> pack.: 1 pc.
<b>LFG 15x15</b> plastic	14,5x14,5mm	white 9010	1	1	<b>14111</b> pack.: 80 m	<b>14232</b> pack.: 10 pc.	<b>14238</b> pack.: 4 pc.	<b>14198</b> pack.: 10 pc.	<b>14250</b> pack.: 4 pc.	<b>12288</b> pack.: 4 pc.	
<b>LFG 15x30</b> plastic	17x30mm	white 9010	1	2	<b>11026</b> pack.: 72 m	<b>14878</b> pack.: 4 pc.	<b>14883</b> pack.: 4 pc.	<b>11693</b> pack.: 10 pc.	<b>14888</b> pack.: 4 pc.	<b>12297</b> pack.: 4 pc.	<b>16659</b> pack.: 1 pc.
<b>LFH 15x30 hf</b> halogen-free plastic	17x30mm	white 9010	1	2	<b>4780</b> pack.: 72 m	<b>14500</b> pack.: 4 pc.	<b>14501</b> pack.: 4 pc.	<b>14501</b> pack.: 10 pc.	<b>14501</b> pack.: 4 pc.		
<b>LFG 15x50</b> plastic	17x50mm	white 9010	3	3	<b>11530</b> pack.: 50 m	<b>14893</b> pack.: 4 pc.	<b>14898</b> pack.: 4 pc.	<b>14807</b> pack.: 10 pc.	<b>14812</b> pack.: 4 pc.	<b>16660</b> pack.: 4 pc.	<b>16658</b> pack.: 1 pc.
<b>LFG 15x50 t</b> plastic, with two tracks	17x50mm	white 9010	2	2	<b>11526</b> pack.: 50 m	<b>14893</b> pack.: 4 pc.	<b>14898</b> pack.: 4 pc.	<b>14807</b> pack.: 10 pc.	<b>14812</b> pack.: 4 pc.	<b>16660</b> pack.: 4 pc.	<b>16658</b> pack.: 1 pc.
<b>LFG 20x20</b> plastic	17x18mm	white 9010	1	1	<b>11025</b> pack.: 54 m						
<b>LFG 25x25</b> plastic	25x25mm	white 9010	2	3	<b>12815</b> pack.: 72 m						
<b>LFG 25x40</b> plastic	27x40mm	white 9010	4	5	<b>11028</b> pack.: 40 m	<b>14982</b> pack.: 4 pc.	<b>14987</b> pack.: 4 pc.	<b>14992</b> pack.: 10 pc.	<b>14856</b> pack.: 4 pc.	<b>13449</b> pack.: 4 pc.	
<b>LFH 25x40 hf</b> halogen-free plastic	27x40mm	white 9010	4	5	<b>4781</b> pack.: 40 m	<b>14505</b> pack.: 4 pc.	<b>14506</b> pack.: 4 pc.	<b>14507</b> pack.: 10 pc.	<b>14508</b> pack.: 4 pc.		
<b>LFG 30x30</b> plastic	32x30mm	white 9010	4	5	<b>11027</b> pack.: 50 m	<b>12142</b> pack.: 4 pc.	<b>12187</b> pack.: 4 pc.	<b>11826</b> pack.: 10 pc.	<b>12195</b> pack.: 4 pc.	<b>12397</b> pack.: 4 pc.	
<b>LFG 40x40</b> plastic	40x40mm	white 9010	6	7	<b>11029</b> pack.: 40 m	<b>11095</b> pack.: 2 pc.	<b>11855</b> pack.: 2 pc.	<b>11096</b> pack.: 10 pc.	<b>11097</b> pack.: 2 pc.		
<b>LFG 40x60</b> plastic, incl. 2 cable clips per meter	40x57mm	white 9010	8	10	<b>11030</b> pack.: 28 m	<b>11114</b> pack.: 2 pc.	<b>11856</b> pack.: 2 pc.	<b>11198</b> pack.: 2 pc.	<b>11170</b> pack.: 2 pc.		
<b>LFG 40x60 t</b> plastic, incl. 2 cable clips per meter, with two tracks	40x57mm	white 9010	7	9	<b>11060</b> pack.: 24 m	<b>11114</b> pack.: 2 pc.	<b>11856</b> pack.: 2 pc.	<b>11198</b> pack.: 2 pc.	<b>11170</b> pack.: 2 pc.		

<sup>A</sup> Filling level: 50% · \* Device installation: see „Accessories“ · Other colours on request · All indications without engagement, subject to modifications · All pictures and drawings similar

# INSTALLATION TRUNKING SYSTEM (plastic)

## Purpose of the system and usage recommendation for the FB installation trunking system:

Workstation installations in offices, workshops, warehouses and laboratories regularly subject to high mechanical loads and with functional interior architectural designs (garages, parking ramps, gas stations, basements, hobby rooms).

## Mounting properties and system accessories for the FB installation trunking system (excerpt of product range):

Base and cover of the trunkings are 2 m in length, the trunking base is perforated and with a continuously molded DIN rail for the click-mounting of accessory boxes and separation plates to separate the systems. The cover piece covers the base completely and the trunking base is easy to access so there is space for installing the cables. Molded parts (inside corners, outside corners, flat angles) and wall brackets are available. End pieces can be inserted to obtain a clean look. Colour: pure white (9010); other colours on request.

## Device installation options for FB installation trunking system:

Trunking height 60mm: Compatible with almost all commercially available switch ranges for flush-mounted installation using standard accessory boxes (single and double) in face plates or for the use of KSE prewired socket units (double and triple). Alternative: MR modular frame for the use of M45 device modules.

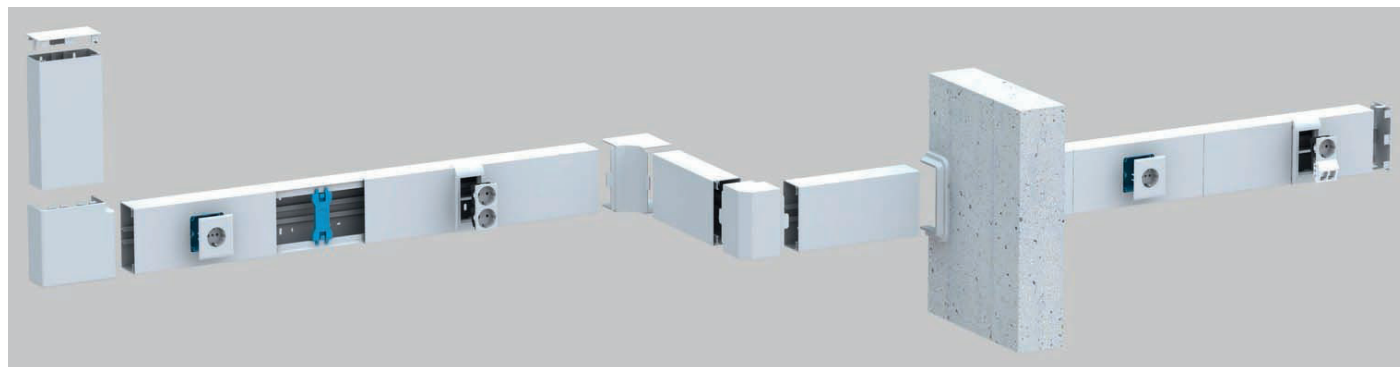

	Dimension height x width	Colour	Wiring		Set base+cover	Inside corner	Outside corner	End piece	Vertical corner	Modular frame* M45
			NYM J3x1,5 Ø 9,1mm	CAT 7 (data) Ø 8,0mm						
<b>LFG 40x90</b> plastic, incl. 2 cable clips per meter	40x90mm	white 9010	11 <sup>A</sup> /6 <sup>B</sup>	16 <sup>A</sup> /7 <sup>B</sup>	<b>11072</b> pack.: 12 m	<b>11866</b> pack.: 2 pc.	<b>11870</b> pack.: 1 pc.	<b>11088</b> pack.: 2 pc.	<b>11084</b> pack.: 2 pc.	<b>16652<sup>1</sup></b> pack.: 1 pc.
<b>LFG 40x110</b> plastic, incl. 2 cable clips per meter	40x110mm	white 9010	14 <sup>A</sup> /7 <sup>B</sup>	17 <sup>A</sup> /8 <sup>B</sup>	<b>11462</b> pack.: 12 m	<b>11878</b> pack.: 2 pc.	<b>11882</b> pack.: 2 pc.	<b>11890</b> pack.: 5 pc.	<b>11886</b> pack.: 1 pc.	<b>16653<sup>1</sup></b> pack.: 1 pc.
<b>LFG 40x150</b> plastic, incl. 2 cable clips per meter	40x150mm	white 9010	17 <sup>A</sup> /8 <sup>B</sup>	21 <sup>A</sup> /9 <sup>B</sup>	<b>11810</b> pack.: 12 m	<b>11487</b> pack.: 2 pc.	<b>11488</b> pack.: 2 pc.	<b>11522</b> pack.: 10 pc.	<b>11872</b> pack.: 1 pc.	<b>16655<sup>2</sup></b> pack.: 1 pc.
<b>LFG 60x60</b> plastic, incl. 2 cable clips per meter	61x57mm	white 9010	12 <sup>A</sup>	16 <sup>A</sup>	<b>11031</b> pack.: 16 m	<b>11115</b> pack.: 2 pc.	<b>11857</b> pack.: 2 pc.	<b>11199</b> pack.: 10 pc.	<b>11171</b> pack.: 2 pc.	
<b>LFG 60x90</b> plastic, incl. 2 cable clips per meter	61x90mm	white 9010	18 <sup>A</sup> /11 <sup>B</sup>	21 <sup>A</sup> /13 <sup>B</sup>	<b>11032</b> pack.: 16 m	<b>11116</b> pack.: 2 pc.	<b>11858</b> pack.: 2 pc.	<b>11200</b> pack.: 10 pc.	<b>11172</b> pack.: 2 pc.	<b>16652<sup>1</sup></b> pack.: 1 pc.
<b>FB 60x110</b> plastic, incl. 2 cable clips per meter	62x110mm	white 9010	20 <sup>A</sup> /7 <sup>C</sup>	28 <sup>A</sup> /9 <sup>C</sup>	<b>11033</b> pack.: 8 m	<b>11117</b> pack.: 2 pc.	<b>11145</b> pack.: 2 pc.	<b>11201</b> pack.: 10 pc.	<b>11173</b> pack.: 2 pc.	<b>16653<sup>1</sup></b> pack.: 1 pc.
<b>FB 60x130</b> plastic, incl. 2 cable clips per meter	62x130mm	white 9010	26 <sup>A</sup> /10 <sup>C</sup>	32 <sup>A</sup> /12 <sup>C</sup>	<b>11034</b> pack.: 10 m	<b>11118</b> pack.: 2 pc.	<b>11146</b> pack.: 2 pc.	<b>11202</b> pack.: 10 pc.	<b>11174</b> pack.: 2 pc.	<b>16654<sup>2</sup></b> pack.: 1 pc.
<b>FB 60x150</b> plastic, incl. 2 cable clips per meter	62x150mm	white 9010	28 <sup>A</sup> /12 <sup>C</sup>	35 <sup>A</sup> /15 <sup>C</sup>	<b>11035</b> pack.: 8 m	<b>11119</b> pack.: 2 pc.	<b>11147</b> pack.: 2 pc.	<b>11203</b> pack.: 10 pc.	<b>11175</b> pack.: 2 pc.	<b>16655<sup>2</sup></b> pack.: 1 pc.
<b>FB 60x200</b> plastic, incl. 2 cable clips per meter	62x190mm	white 9010	36 <sup>A</sup> /20 <sup>C</sup>	49 <sup>A</sup> /23 <sup>C</sup>	<b>11036</b> pack.: 8 m	<b>11120</b> pack.: 2 pc.	<b>11148</b> pack.: 2 pc.	<b>11204</b> pack.: 10 pc.	<b>11176</b> pack.: 2 pc.	
<b>FB 60x230</b> plastic, incl. 2 cable clips per meter	62x230mm	white 9010	48 <sup>A</sup> /25 <sup>C</sup>	52 <sup>A</sup> /28 <sup>C</sup>	<b>11066</b> pack.: 8 m	<b>11798</b> pack.: 1 pc.	<b>14112</b> pack.: 1 pc.	<b>14113</b> pack.: 10 pc.	<b>14114</b> pack.: 1 pc.	
<b>FB 80x150</b> plastic, incl. 2 cable clips per meter	80x150mm	white 9010	42 <sup>A</sup>	50 <sup>A</sup>	<b>11492</b> pack.: 8 m	<b>11894</b> pack.: 2 pc.	<b>14119</b> pack.: 2 pc.	<b>14120</b> pack.: 5 pc.	<b>14121</b> pack.: 2 pc.	<b>16655<sup>2</sup></b> pack.: 1 pc.
<b>FB 100x230</b> plastic, incl. 2 cable clips per meter	100x230mm	white 9010	80 <sup>A</sup>	85 <sup>A</sup>	<b>11093</b> pack.: 4 m	<b>14115</b> pack.: 2 pc.	<b>14116</b> pack.: 2 pc.	<b>14117</b> pack.: 2 pc.	<b>14118</b> pack.: 2 pc.	

<sup>A</sup> Filling level: 50% · <sup>B</sup> Filling level (50%) with MR modular frame · <sup>C</sup> Filling level (50%) with accessory box (GED) · \* Device installation: see „Accessories“ · Other colours on request · All indications without engagement, subject to modifications.

<sup>1</sup> for 1 M45 device · <sup>2</sup> for 2 M45 devices · All pictures and drawings similar

# INSTALLATION TRUNKING SYSTEM (sheet steel)

## Purpose of the system and usage recommendation for MINI/s and LFS installation trunking system made of sheet steel:

Installation to reduce the fire load in workshops, warehouses, sports facilities and schools with functional interior architectural designs (garages, parking ramps, industries) regularly subject to high mechanical loads.

## Mounting properties and system accessories for the MINI/s and LFS installation trunking system made of sheet steel (excerpt of product range):

Base and cover of the trunkings are 2 m in length and the trunking base is without perforation. The cover piece covers the base completely and the trunking base is easy to access so there is space for installing the cables. It is possible to change the direction elegantly using products from the full range of accessories. Molded cover parts (inside corners, outside corners, vertical corners) are available to hide cut edges. End pieces can be inserted to obtain a clean look. Grounding straps for equipotential bonding (grounding cables must be ordered separately) and cable clips. Available in pure white (9010) as well as in any other RAL colour. Also suitable for painting over. On request available with perforated base and / or welded separation plate.

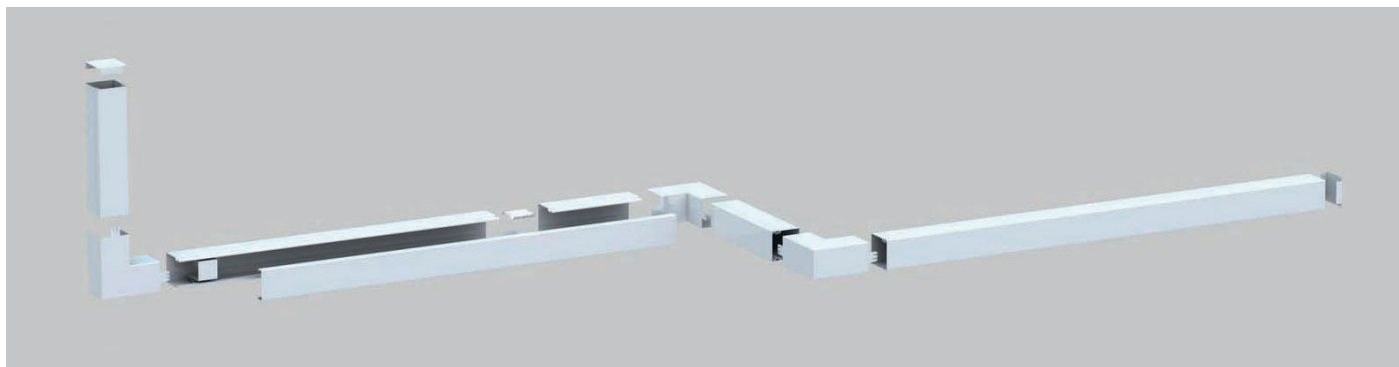

	Dimension height x width	Colour	Wiring <sup>A</sup>		Set base+cover	Inside corner	Outside corner	End piece	Vertical corner	T-piece	Cable clip
			NYM J3x1,5 Ø 9,1mm	NYM J5x1,5 Ø 10,8mm							
<b>MINI/s 15x15</b> with base perforation	15x15mm	coated in white 9010	1	1	<b>24600</b> pack.: 50 m	<b>14232*</b> pack.: 10 pc.	<b>14238*</b> pack.: 4 pc.	<b>14198*</b> pack.: 10 pc.	<b>14250*</b> pack.: 4 pc.	<b>12288*</b> pack.: 4 pc.	
<b>MINI/s 15x15</b> with base perforation	15x15mm	hot dip coated	1	1	<b>4600</b> pack.: 50 m	<b>4229*</b> pack.: 10 pc.	<b>4235*</b> pack.: 4 pc.	<b>4195*</b> pack.: 10 pc.	<b>4247*</b> pack.: 4 pc.	<b>2284*</b> pack.: 4 pc.	
<b>MINI/s 15x30</b> with base perforation	15x30mm	coated in white 9010	2	1	<b>24605</b> pack.: 30 m	<b>14878*</b> pack.: 4 pc.	<b>14883*</b> pack.: 4 pc.	<b>11693*</b> pack.: 10 pc.	<b>14888*</b> pack.: 4 pc.	<b>12297*</b> pack.: 4 pc.	
<b>MINI/s 15x30</b> with base perforation	15x30mm	hot dip coated	2	1	<b>4605</b> pack.: 30 m	<b>4874*</b> pack.: 4 pc.	<b>4879*</b> pack.: 4 pc.	<b>1557*</b> pack.: 10 pc.	<b>4884*</b> pack.: 4 pc.	<b>2289*</b> pack.: 4 pc.	
<b>MINI/s 30x30</b> with base perforation	30x30mm	coated in white 9010	4	2	<b>24610</b> pack.: 32 m	<b>24611</b> pack.: 5 pc.	<b>24612</b> pack.: 5 pc.	<b>24614</b> pack.: 20 pc.	<b>24613</b> pack.: 5 pc.	<b>24617</b> pack.: 10 pc.	
<b>MINI/s 30x30</b> with base perforation	30x30mm	hot dip coated	4	2	<b>4610</b> pack.: 32 m	<b>4611</b> pack.: 5 pc.	<b>4612</b> pack.: 5 pc.	<b>4614</b> pack.: 20 pc.	<b>4613</b> pack.: 5 pc.	<b>4617</b> pack.: 10 pc.	
<b>LFS 40x40</b>	40x40mm	coated in white 9010	6	4	<b>2748</b> pack.: 12 m	<b>2749</b> pack.: 5 pc.	<b>2750</b> pack.: 5 pc.	<b>2752</b> pack.: 20 pc.	<b>2751</b> pack.: 5 pc.		
<b>LFS 40x40</b>	40x40mm	hot dip coated	6	4	<b>2742</b> pack.: 12 m	<b>2743</b> pack.: 5 pc.	<b>2744</b> pack.: 5 pc.	<b>2746</b> pack.: 20 pc.	<b>2745</b> pack.: 5 pc.		
<b>LFS 40x60</b>	40x60mm	coated in white 9010	9	7	<b>2301</b> pack.: 12 m	<b>2311</b> pack.: 5 pc.	<b>2321</b> pack.: 5 pc.	<b>2341</b> pack.: 20 pc.	<b>2331</b> pack.: 5 pc.		
<b>LFS 40x60</b>	40x60mm	hot dip coated	9	7	<b>2300</b> pack.: 12 m	<b>2310</b> pack.: 5 pc.	<b>2320</b> pack.: 5 pc.	<b>2340</b> pack.: 20 pc.	<b>2330</b> pack.: 5 pc.		
<b>LFS 60x60</b>	60x60mm	coated in white 9010	14	10	<b>2303</b> pack.: 8 m	<b>2313</b> pack.: 5 pc.	<b>2323</b> pack.: 5 pc.	<b>2343</b> pack.: 20 pc.	<b>2333</b> pack.: 5 pc.		<b>2950</b> pack.: 100 pc.
<b>LFS 60x60</b>	60x60mm	hot dip coated	14	10	<b>2302</b> pack.: 8 m	<b>2312</b> pack.: 5 pc.	<b>2322</b> pack.: 5 pc.	<b>2342</b> pack.: 20 pc.	<b>2332</b> pack.: 5 pc.		<b>2950</b> pack.: 100 pc.

<sup>A</sup> Filling level: 50% - \* accessories MINI/s 15x15 and MINI/s 15x30 made from plastic - Other colours on request - All indications without engagement, subject to modifications - All pictures and drawings similar

# INSTALLATION TRUNKING SYSTEM (sheet steel)

## Purpose of the system and usage recommendation for the LFS / FBS installation trunking system made of sheet steel:

Installation to reduce the fire load in offices, workshops, warehouses and laboratories with functional interior architectural designs (garages, parking ramps, gas stations, basements, hobby rooms) regularly subject to high mechanical loads.

## Mounting properties and system accessories for the LFS / FBS installation trunking system made of sheet steel (excerpt of product range):

LFS: Base and cover of the trunkings are 2 m in length. The cover piece covers the base completely and the trunking base is easy to access so there is space for installing the cables. It is possible to change the direction elegantly using products from the full range of accessories. Molded cover parts (inside corners, outside corners, vertical corners) are available to hide cut edges. End pieces can be inserted to obtain a clean look. Grounding straps for equipotential bonding (grounding cables must be ordered separately) and cable clips. Available in pure white (9010) as well as in any other RAL colour. Also suitable for painting over. On request available with perforated base and / or welded separation plate. FBS: Like the LFS, but also with a welded DIN mounting rail for inserting a separation plate and / or for installing devices.

## Device installation options for the FBS cable trunking system made of sheet steel:

FBS: Compatible with almost all commercially available switch ranges for flush-mounted installation using standard accessory boxes (single and double) in face plates or for the use of KSE prewired socket units (double and triple) on a DIN mounting rail.

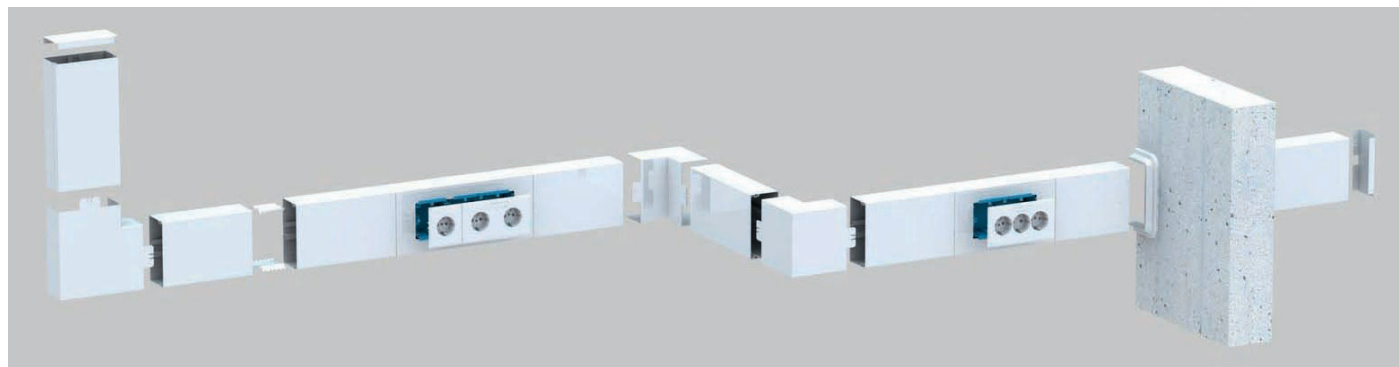





	Dimension height x width	Colour	Wiring		Set base+cover	Inside corner	Outside corner	End piece	Vertical corner	Cable clip
			NYM J3x1,5 Ø 9,1mm	NYM J5x1,5 Ø 10,8mm						
<b>LFS 60x100</b>	60x100mm	coated in white (9010)	26 <sup>A</sup>	17 <sup>A</sup>	<b>2305</b> pack.: 4 m	<b>2315</b> pack.: 2 pc.	<b>2325</b> pack.: 2 pc.	<b>2345</b> pack.: 10 pc.	<b>2335</b> pack.: 2 pc.	<b>2951</b> pack.: 100 pc.
<b>LFS 60x100</b>	60x100mm	hot dip coated	26 <sup>A</sup>	17 <sup>A</sup>	<b>2304</b> pack.: 4 m	<b>2314</b> pack.: 2 pc.	<b>2324</b> pack.: 2 pc.	<b>2344</b> pack.: 10 pc.	<b>2334</b> pack.: 2 pc.	<b>2951</b> pack.: 100 pc.
<b>FBS 60x100</b> with welded mounting rail	60x100mm	coated in white (9010)	26 <sup>A</sup> /7 <sup>B</sup>	17 <sup>A</sup> /4 <sup>B</sup>	<b>2351</b> pack.: 4 m	<b>2315</b> pack.: 2 pc.	<b>2325</b> pack.: 2 pc.	<b>2345</b> pack.: 10 pc.	<b>2335</b> pack.: 2 pc.	<b>2951</b> pack.: 100 pc.
<b>LFS 60x130</b>	60x130mm	coated in white (9010)	32 <sup>A</sup>	24 <sup>A</sup>	<b>7992</b> pack.: 4 m	<b>2853</b> pack.: 2 pc.	<b>2854</b> pack.: 2 pc.	<b>2856</b> pack.: 10 pc.	<b>2855</b> pack.: 2 pc.	<b>2952</b> pack.: 100 pc.
<b>LFS 60x130</b>	60x130mm	hot dip coated	32 <sup>A</sup>	24 <sup>A</sup>	<b>7990</b> pack.: 4 m	<b>2847</b> pack.: 2 pc.	<b>2848</b> pack.: 2 pc.	<b>2850</b> pack.: 10 pc.	<b>2849</b> pack.: 2 pc.	<b>2952</b> pack.: 100 pc.
<b>FBS 60x130</b> with welded mounting rail	60x130mm	coated in white (9010)	32 <sup>A</sup> /13 <sup>B</sup>	24 <sup>A</sup> /9 <sup>B</sup>	<b>2852</b> pack.: 4 m	<b>2853</b> pack.: 2 pc.	<b>2854</b> pack.: 2 pc.	<b>2856</b> pack.: 10 pc.	<b>2855</b> pack.: 2 pc.	<b>2952</b> pack.: 100 pc.
<b>LFS 60x150</b>	60x150mm	coated in white (9010)	38 <sup>A</sup>	30 <sup>A</sup>	<b>2307</b> pack.: 4 m	<b>2317</b> pack.: 2 pc.	<b>2327</b> pack.: 2 pc.	<b>2347</b> pack.: 10 pc.	<b>2337</b> pack.: 2 pc.	<b>2953</b> pack.: 100 pc.
<b>LFS 60x150</b>	60x150mm	hot dip coated	38 <sup>A</sup>	30 <sup>A</sup>	<b>2306</b> pack.: 4 m	<b>2316</b> pack.: 2 pc.	<b>2326</b> pack.: 2 pc.	<b>2346</b> pack.: 10 pc.	<b>2336</b> pack.: 2 pc.	<b>2953</b> pack.: 100 pc.
<b>FBS 60x150</b> with welded mounting rail	60x150mm	coated in white (9010)	38 <sup>A</sup> /17 <sup>B</sup>	30 <sup>A</sup> /11 <sup>B</sup>	<b>2353</b> pack.: 4 m	<b>2317</b> pack.: 2 pc.	<b>2327</b> pack.: 2 pc.	<b>2347</b> pack.: 10 pc.	<b>2337</b> pack.: 2 pc.	<b>2953</b> pack.: 100 pc.
<b>LFS 60x200</b>	60x200mm	coated in white (9010)	45 <sup>A</sup>	38 <sup>A</sup>	<b>2309</b> pack.: 4 m	<b>2319</b> pack.: 2 pc.	<b>2329</b> pack.: 2 pc.	<b>2349</b> pack.: 10 pc.	<b>2339</b> pack.: 2 pc.	<b>2954</b> pack.: 100 pc.
<b>LFS 60x200</b>	60x200mm	hot dip coated	45 <sup>A</sup>	38 <sup>A</sup>	<b>2308</b> pack.: 4 m	<b>2318</b> pack.: 2 pc.	<b>2328</b> pack.: 2 pc.	<b>2348</b> pack.: 10 pc.	<b>2338</b> pack.: 2 pc.	<b>2954</b> pack.: 100 pc.
<b>FBS 60x200</b> with welded mounting rail	60x200mm	coated in white (9010)	45 <sup>A</sup> /27 <sup>B</sup>	38 <sup>A</sup> /18 <sup>B</sup>	<b>2355</b> pack.: 4 m	<b>2319</b> pack.: 2 pc.	<b>2329</b> pack.: 2 pc.	<b>2349</b> pack.: 10 pc.	<b>2339</b> pack.: 2 pc.	<b>2954</b> pack.: 100 pc.
<b>LFS 60x230</b>	60x230mm	coated in white (9010)	62 <sup>A</sup>	40 <sup>A</sup>	<b>2808</b> pack.: 4 m	<b>2809</b> pack.: 2 pc.	<b>2810</b> pack.: 2 pc.	<b>2812</b> pack.: 10 pc.	<b>2811</b> pack.: 2 pc.	<b>2955</b> pack.: 100 pc.
<b>LFS 60x230</b>	60x230mm	hot dip coated	62 <sup>A</sup>	40 <sup>A</sup>	<b>2802</b> pack.: 4 m	<b>2803</b> pack.: 2 pc.	<b>2804</b> pack.: 2 pc.	<b>2806</b> pack.: 10 pc.	<b>2805</b> pack.: 2 pc.	<b>2955</b> pack.: 100 pc.
<b>FBS 60x230</b> with welded mounting rail	60x230mm	coated in white (9010)	62 <sup>A</sup> /34 <sup>B</sup>	40 <sup>A</sup> /22 <sup>B</sup>	<b>2882</b> pack.: 4 m	<b>2809</b> pack.: 2 pc.	<b>2810</b> pack.: 2 pc.	<b>2812</b> pack.: 10 pc.	<b>2811</b> pack.: 2 pc.	<b>2955</b> pack.: 100 pc.

## ACCESSORIES (selected)





### M45 DEVICE INSTALLATION

for MB **Modular box**  
for MR **Modular frame**

	Description	Dimension	Colour	Art. no
	M45 SCHUKO socket, (16A, 250V), double pole, single, 33° inclined, with clamp terminals	45x45mm	white	<b>6964</b> pack.: 1 pc.
	M45 SCHUKO socket, (16A, 250V), double pole, single, vertically aligned, with clamp terminals	45x45mm	white	<b>6960</b> pack.: 1 pc.
	M45 Keystone-Adapter, double hole	45x45mm	white	<b>6631</b> pack.: 1 pc.
	M45 Systimax-Adapter, double hole, with label field	45x45mm	white	<b>6636</b> pack.: 1 pc.

### M45 DEVICE INSTALLATION

for MB **Modular box**  
for MR **Modular frame**

	Description	Dimension	Colour	Art. no
	M45 Toggle switch (16A, 250V), 2-way switch, single pole, with clamp terminals	45x45mm	white	<b>6989</b> pack.: 1 pc.
	M45 Rocker switch (16A, 250V), 1-way switch, double pole, with clamp terminals	45x45mm	white	<b>7026</b> pack.: 1 pc.
	M45 Pushbutton (16A, 250V), 2-way pushbutton, single pole, with clamp terminals	45x45mm	white	<b>7029</b> pack.: 1 pc.
	M45 Roller shutter rocker switch (10A, 250V), with electrical and mechanical interlocking, single pole, with clamp terminals	45x45mm	white	<b>7025</b> pack.: 1 pc.



### SEPARATION PLATES

	Description	Dimension	Colour	Art. no
	Separation plate 40, for PVC trunkings with 40mm height, starting with LFG 40x90	40mm	not defined	<b>1360</b> pack.: 100m
	Separation plate 60, for PVC trunkings with 60mm height, starting with LFG 60x60	60mm	not defined	<b>1260</b> pack.: 100m
	Separation plate 60 extra, for PVC trunkings with 60mm height, for middle division, starting with FB 60x110	60mm	not defined	<b>1456</b> pack.: 50m

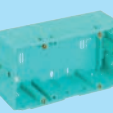

### ACCESSORY BOXES

	Description	Dimension	Colour	Art. no
	GED 50 accessory box, single hole, floor-mounted, for standard 80mm devices, for FB and FBS installation trunkings	80x80mm	blue	<b>1261</b> pack.: 40 pc.
	GED 50/2 accessory box, double hole, floor-mounted, for standard 80mm devices, for FB and FBS installation trunkings	80x80mm	blue	<b>1280</b> pack.: 20 pc.

### GROUNDING MATERIAL

	Description	Dimension	Colour	Art. no
	Grounding strip with cable lug, 300mm length, for trunkings made from sheet steel		not defined	<b>1640</b> pack.: 50 pc.
	USV 60 universal joint and grounding clip connector, made from spring steel, for steel trunkings with 60mm height		not defined	<b>2959</b> pack.: 20 pc.

### PREWIRED SOCKET UNITS

	Description	Dimension	Colour	Art. no
	KSE 50/Dialog-2 prewired socket unit, double SCHUKO, incl. label field, for FB / FBS installation trunkings	80x80mm	white	<b>21280</b> pack.: 4pc.
	KSE 50/Dialog-3 prewired socket unit, triple SCHUKO, incl. label field, for FB / FBS installation trunkings	80x80mm	white	<b>31280</b> pack.: 4pc.

### FURTHER ACCESSORIES ON REQUEST

All indications without engagement, subject to modifications · All pictures and drawings similar



- Leading specialist in plastic and metal cable management systems
- Owner managed, group-independent company
- Modern production plant
- Environmentally friendly, resource-efficient production
- Own, innovative product development



- High product availability from stock
- Wide variety of national and international certificates
- Certification according to ISO 9001:2008 
- High quality products „Made in Germany“
- Over 25 years of experience



## GGK GmbH & Co. KG

Gerhard-Grün-Str. 1  
35753 Greifenstein-Beilstein  
Germany

Phone: +49 (0) 2779 / 915-0

Fax +49 (0) 2779 / 915-122

e-mail: [export@ggk-online.com](mailto:export@ggk-online.com)

Internet: [www.ggk-online.com](http://www.ggk-online.com)